

Wall thickness: 0.5mm

Span distance: 10mm

90° Overhang: 3mm

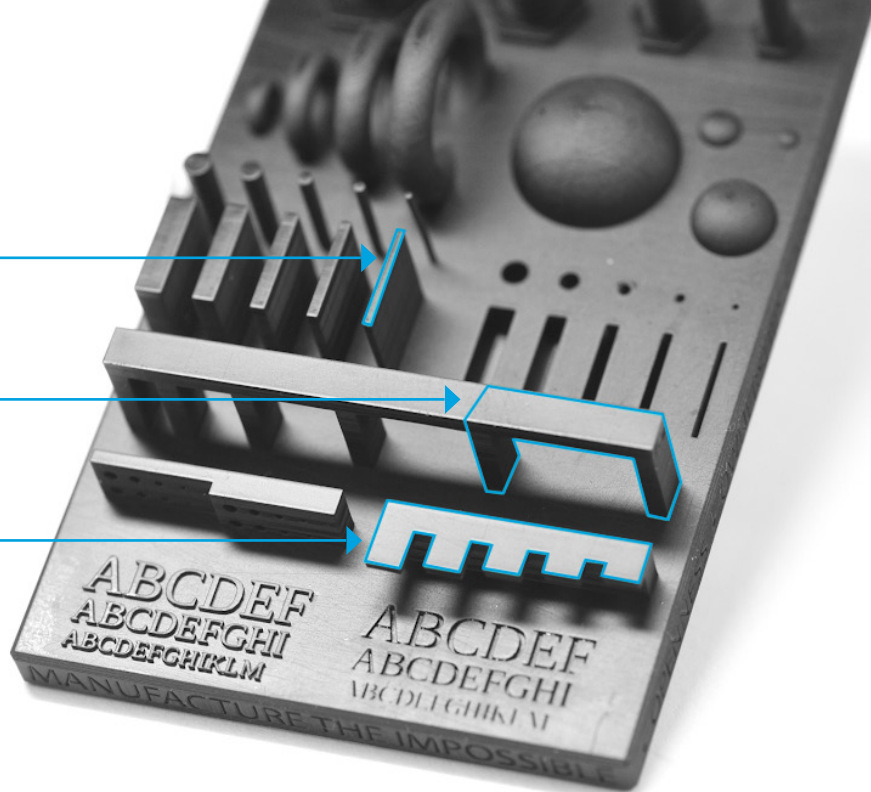

Stratasys Origin One Design Guide

Overview

Origin One's Programmable Photopolymerization (P3) process is capable of printing difficult geometries without supports, fine features, and large cross-sections, with excellent surface quality comparable to injection molding.

However, like traditional manufacturing processes, there are guidelines that result in the highest yields, optimal quality, and reduced labor. Fortunately, familiar traditional techniques, like filleting, adding ribs, and orientation go a long way toward reducing the number of sacrificial supports required and increasing production throughput.

This design guide is intended to help readers understand the Stratasys Origin One's capabilities, select candidate parts for additive production, and learn how to design additive parts for the best throughput and quality on Origin One.



Common Types of 3D Printing Technology

Different print processes will have unique design considerations, based on the additive technique being used. Origin One's process is within the vat photopolymerization category. If you're familiar with Stereolithography (SLA) or Digital Light Processing (DLP) printers, many of the same design principles will apply to Origin One's Programmable Photopolymerization (P³) process.



The Stratasys Origin One's P³ process evolves from DLP, a type of vat photo-polymerization.

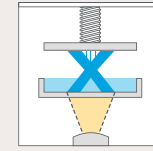

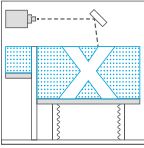
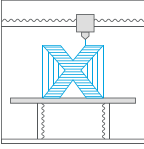
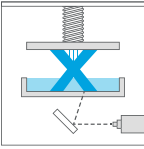
Technology	Description
 <p>Powder</p>	<p>Several types of 3D printing utilize thermoplastic powder—SLS uses laser energy to sinter powder into a solid part. MJF uses a printed binder to temporarily fuse powder, which is subsequently sintered into the final part.</p>
 <p>Filament</p>	<p>Known as Fused Deposition Modeling (FDM) or Fused Filament Fabrication (FFF), this technology starts with a spool of thermoplastic filament and selectively extrudes it along a tool path determined by the geometry of each slice.</p>
 <p>Resin (Vat Photo- Polymerization)</p>	<p>SLA and DLP are the two main categories of resin 3D printing. Both convert a liquid to a solid by using light to polymerize a photopolymer resin. SLA uses a laser that traces each slice, while DLP uses a projector to simultaneously expose an entire slice.</p>

How it Works

The Stratasys Origin One's P³ process precisely orchestrates light, temperature, and other conditions to automatically optimize prints in real time for the best possible results.

Once the 3D model is sent to the printer, a vat of photopolymer is exposed to light from a UV projector. The UV projector displays a pattern of light onto the build head area. The exposed liquid polymer hardens, and the build plate then moves, allowing resin to flow underneath the hardened layer. Then, the liquid polymer is exposed to light once more. The process is repeated until the 3D model is complete.

P³ converts resins into highly crosslinked thermoset parts. Parts are almost fully polymerized during the print process. Post-processing involves removing any supports, cleaning the part in a solvent for a few minutes, and then curing the part for several minutes under a separate UV cure system.

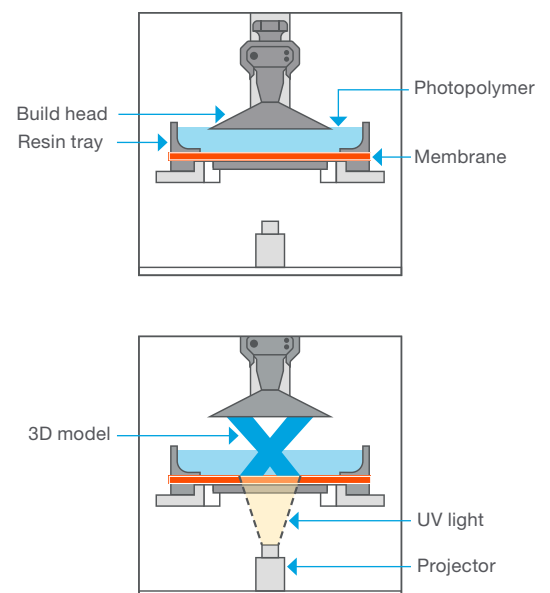

Stratasys Origin One Feature Capabilities

The Stratasys Origin One's process enables printing of highly detailed features with excellent surface quality. While material and geometry play an important role, features we have successfully printed are highlighted on the model to the right.

Minimum feature sizes and process limitations are highly geometry-dependent. Feature sizes, process limitations, and print settings are also material-dependent.

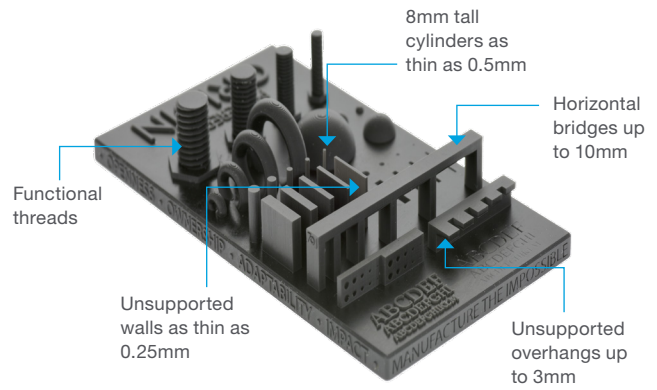

Advantages of the Stratasys Origin One Over Other Additive Technologies

Production

Minimal supports: High green strength materials are almost fully cured during the print process and require fewer supports than other vat polymerization technologies, lowering overall labor and material usage.

Injection molded surface quality: Achieve smooth surfaces and detailed textures during the print process without secondary operations.

Post-process in minutes: High green strength, coupled with P3, produces isotropic parts with peak mechanical properties during printing. A quick clean and UV cure results in an end-use part.

Design

Exceptional accuracy: The Stratasys Origin One's process enables the fine-tuning of print parameters to achieve industry-leading accuracy that enables production of materials with features under 50µm.

Handle difficult geometries: Produce parts with which other additive technologies struggle, including models with fine features or unsupported gaskets, as well as large, cross-sectional applications, like molds.

Materials

Wide range of materials: Print with resilient elastomers, heat-resistant polymers, biocompatible formulations, and other high-performance materials from our ecosystem material partners, including BASF, Henkel, and DSM.

Control your supply chain: Work directly with material partners to optimize material for specific applications, and take advantage of secondary sourcing to avoid supply disruptions.

Why Design for Additive?

When using additive manufacturing for end-use parts, designing for the technology becomes critical for quality, functionality, and throughput, which results in lower overall costs and increases the number of viable applications for additive production.

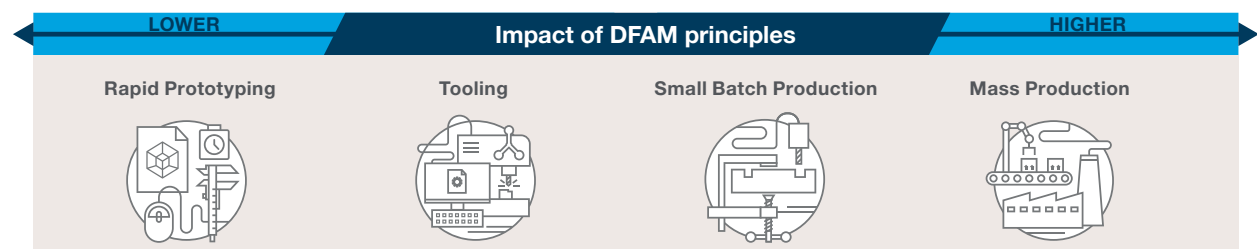

How to Choose the Right Part for AM

When considering end-use parts to additively produce, it's worth spending some time looking at existing production parts, to identify use cases where it could be cost-effective and more efficient to print the parts.

Some general considerations include:

- Customization and SKU variation: Print parts and products customized to users, companies, or specific customer segments, such as automotive connectors, footwear, or dental products.
- Lightweighting: Increase product life and reduce material usage, fuel, and maintenance costs with lattice structures and topology optimization. GE's fuel nozzle is a good example.
- Tight tolerances and fine features: Improve fit and function with tolerances that exceed those of typical injection molded or CNC parts. Typically, small, accurate polymer parts are more suitable for additive, rather than subtractive.
- Low-volume production: Avoid or postpone the high fixed cost of injection molds by printing parts directly or printing high heat molds.
- Time to market: Launch products faster and incorporate feedback quickly to accelerate innovation.

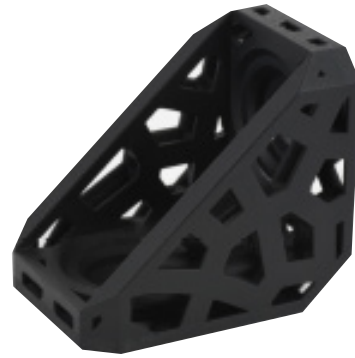

Before You Print Checklist

When identifying a part or design to take advantage of additive manufacturing, it's important to answer these questions first.

Questions to consider:

- Is a suitable material available for the application?
- Will it fit inside the build volume?
- Are there any features / walls smaller than 200µm (0.2mm)?
- Are there overhangs?
- Are supports needed on any critical surfaces?
- Are there areas where resin can't escape?





Choosing a Material

Once you have identified which part to print, the next step is selecting the right material for your part. Review the Stratasys Origin One material portfolio and each material's physical properties to select the best one for your application.

Various materials require specific printer settings. Typically, rigid materials can handle thinner walls than soft materials and will require fewer supports.

The Stratasys Origin One is highly configurable, with numerous settings that can be modified. For example, long and thin parts made from a soft material may require a longer delay between exposure, and users can easily modify the printer's settings accordingly.

Material Category	Description	Properties	Unique Print Considerations
Rigid	Rigid materials typically have the highest green strength, so they become mechanically strong during the print process and can also print faster.	<ul style="list-style-type: none"> • Stiffness • Strength • Toughness • Thermal resistance 	Rigid materials achieve the smallest feature sizes, biggest overhangs, and greatest detail, with minimal supports.
Tough	Tough materials live between rigid and elastomeric. With moderate moduli and increased elongation, these materials demonstrate high impact strength.	<ul style="list-style-type: none"> • Strength • Toughness • Moderate flexibility • Moderate elongation 	Tough materials require moderate supports on overhangs, yet are still capable of achieving fine detail.
Elastomers	Elastomers are stretchy and highly flexible. The flexible nature of these materials requires the most supports and slowest print speeds.	<ul style="list-style-type: none"> • High elongation • Highly flexible • Resiliency 	Elastomers require the most support on overhangs and tall parts, to ensure geometric accuracy and part quality.

Build Volume

Your part needs to fit inside the build envelope to be printed as one part. The build volume of the Stratasys Origin One is 192 x 108 x 370mm. The bounding box of your part in the preferred orientation must fit inside this volume in order to be printable on a Stratasys Origin One.

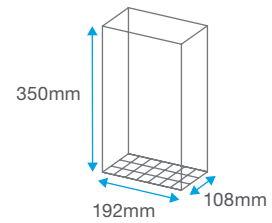

Orientation Vs. Print Time

Print time on a Stratasys Origin One is primarily dependent on material and the height of the part in the Z direction. Geometry is less of a factor in print time, compared to other additive technologies.

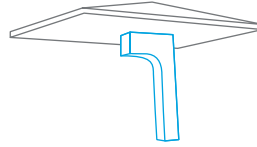

In this orientation, the part is taller in the Z dimension and will take longer to print

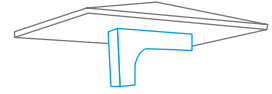

In this orientation, the part is shorter in Z, and will print ~2x faster

Part Orientation

Part orientation will directly impact the final part in several ways, so it's an important item to consider when designing a part and preparing a print.

- Orient the part so that it is in a stable orientation.
- Ensure the part adheres to the build head. Is there a flat surface that can be placed on the build head? If not, is there adequate surface area attached to the build head?
- Which surfaces need to be support-free?
- Is there an orientation that requires fewer supports (to reduce material waste and labor)?

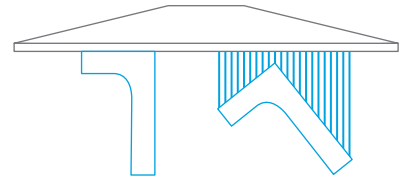

The part on the left is oriented directly against the build head and has a stable center of mass, so it doesn't require supports in this orientation. The part on the right is oriented such that it needs supports.

Orientation Vs. Surface Quality

The Stratasys Origin One is capable of printing parts with high accuracy, small features, and a beautiful surface finish. Surface orientation can affect the surface finish—the differences are subtle but may matter, depending on your use case.

The best surface will be a flat surface printed directly parallel to the build head. Obviously, this doesn't leave much room for design freedom. The second best surface quality will be a curved or flat part that is angled to the build head (not a perpendicular flat surface). Most surfaces of most parts will fall into this category.

The most challenging surface orientation is a flat surface that is perpendicular to the build head, as you'll notice subtle layer lines in the Z direction.

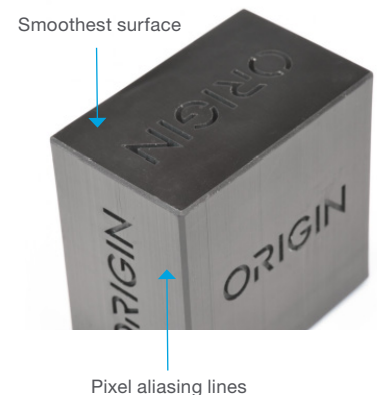

Design for Surface Finish

If a surface has to be maximally smooth, the best way to get a smooth surface is to keep it horizontal (parallel) to the build head. Another option is to decrease layer thickness—thinner layers will result in a better surface finish, but print times will increase. Any part printed at an angle will show subtle layer lines. Surfaces oriented towards the build head will appear smoother than surfaces oriented away from the build head.

Support Considerations

The nature of bottom-up photopolymer systems requires supports for some geometries, such as overhangs, islands, and undercuts.

Supports are removable, disposable structures that stabilize features like overhangs, as well as any feature that is not supported by the part geometry itself. Engineers and designers can reduce the amount of support required by creating flat surfaces that can be directly adhered to the build plate or by creating self-supporting geometries.

Supports are needed for all resin printers for certain geometries, to ensure that all features of a print adhere to the build head and that pieces do not break off or deform during the printing process.

Main Questions

- Will my part need supports?
- What's my supporting strategy?
- Will there be supports on critical surfaces?
- How tall will the supports be? Taller supports need to be thicker.
- What's the material? Materials with lower green strength need more supports.

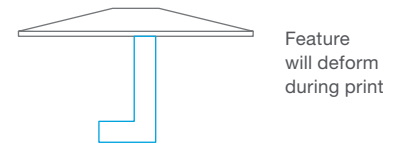

Feature will deform during print

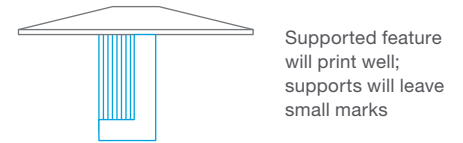

Supported feature will print well; supports will leave small marks

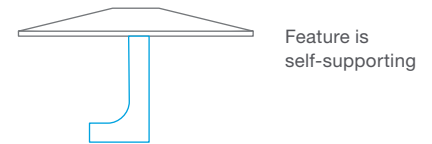

Feature is self-supporting

What is an overhang?

An overhang is a feature on a part that is supported by the part itself, on only one side. A horizontal overhang is perpendicular to the build head, without a part feature holding it up, like the horizontal part of a T. An angled overhang is similar but is partially self-supporting, like the arms of a Y.

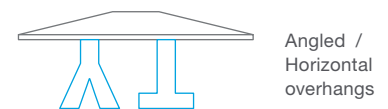

Angled / Horizontal overhangs

What is a bridge?

A bridge is a feature that is supported on its ends but not in the middle. Bridges can be longer than horizontal overhangs but may droop as the span becomes too big.

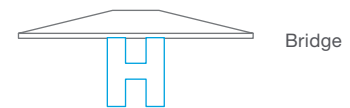

Bridge

What is an island?

An island is a feature that is completely unsupported. When the print gets to the first layer of an island, the newly exposed island region will not have anything to pull up on it during separation, and it will stick to the glass and cause the print to fail.

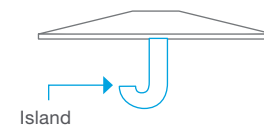

Island

Will my part need supports?

- In the preferred orientation, will there be large overhangs or islands?
 - » If so, you'll need to support those features.
- Is there a flat surface that can be oriented against the build head?
 - » If not, you'll need to support the entire part.

What will my supports look like?

- You'll probably need to support horizontal overhang features if the overhang is longer than ~3mm.
- Angled overhangs may need to be supported, depending on the angle and the length.
 - » Shallower angles are more likely to need supports.
 - › Angled features steeper than $\sim 30^\circ$ are usually self-supporting.
 - » Longer overhangs are more likely to need supports.
- You'll always need to support island features.
- You'll need to support bridges with a span greater than ~10mm.
- All of these guidelines are material dependent.

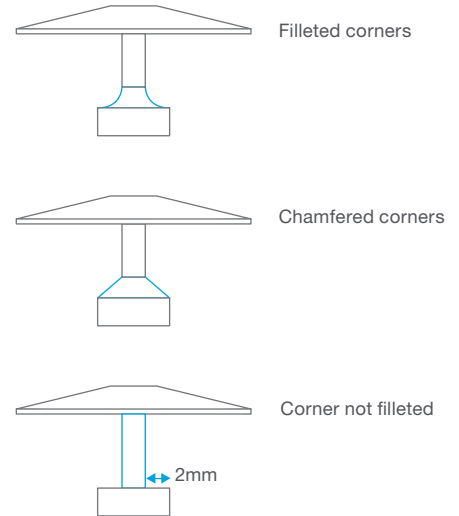

How can I revise my design to reduce or eliminate the need for supports?

- Add fillets, chamfers, or ribs to make geometry self-supporting.
- Minimize the length of horizontal surfaces / features, or design them at an angle.
- Remove unnecessary features.

Fine Features

Print Considerations

Once again, the ability to print parts with small features, such as the structures shown on our challenge part, is heavily dependent on the parts' material, orientation, and geometry. Also, keep in mind that the XY resolution on the Stratasys Origin One is $50\mu\text{m}$, and the Z resolution is user configurable.

Minimum through hole size: 0.2mm

Small holes can be challenging in most additive technologies. For vat polymerization processes, it's an extra important consideration, as overcure can occur and partially fill the gap. Printing the hole perpendicular to the build head will achieve the most accurate and smallest holes.

Feature Size

Feature size is highly dependent on the type of material and aspect ratio. Typically, for negative feature size, 0.4mm is OK, and positive feature sizes can be up to 0.2mm.

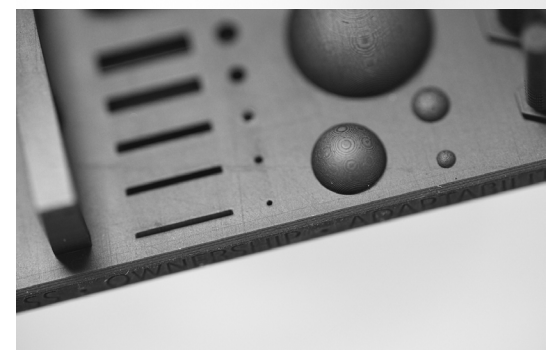
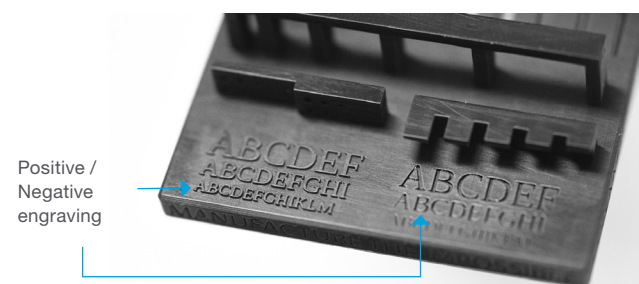

Unsupported Wall Thickness

Unsupported wall thickness is dependent on wall height, aspect ratio, and print direction, as well as material type.

Minimum: 0.25mm

Recommended: 0.5mm

Horizontal Overhangs

Horizontal overhangs typically need supports when they are more than 3mm long and at an angle shallower than $\sim 30^\circ$ for most rigid materials. This is highly material dependent. If you're printing with an elastomer, for example, the critical length will be shorter, and the critical angle will be greater.

Overhangs

- Depends on material and exposure time.
- 1–2 mm is usually safe, 2–3mm is possible.
- Angled overhangs can be much longer.

Enclosed Volumes

An enclosed volume will not allow resin to escape during the printing process and would not be a useful part, as uncured resin would be trapped in the final part. Allow for a resin drain hole in all parts with enclosed volumes.

Angled Overhang

It's best to design parts such that overhangs are greater than 30° ; if not, you'll need to use supports on shallower features.

Printing at an angle less than this will result in layers not adhering, and you will notice a peeling effect.

Angled overhang dependant on:

- Thickness
- Aspect ratio
- Angle
- Material

Separation Forces & Build Head Adhesion

Separation forces are common to many additive technologies and occur between layers, when the build plate moves to make way for new resin to flow into the exposed build area.

If the part is not adequately attached to the build plate, then the part could be damaged or fall off during printing, so it's important to attach enough material on the build head to support the part for the duration of the print.

The Stratasys Origin One uses a unique proprietary separation mechanism that drastically reduces these forces, compared to similar technologies that allow users to easily print gasket-like geometries and large, cross-sectional areas, such as molds.

Cleaning & Postcuring

It's important to consider the cleaning process when designing your part.

Viscous resins, like elastomers, will be harder to clean than resins with a lower viscosity, such as rigid materials.

Very dense lattices are also challenging to clean—it can be difficult (time-consuming) to remove resin from the core of the lattice.

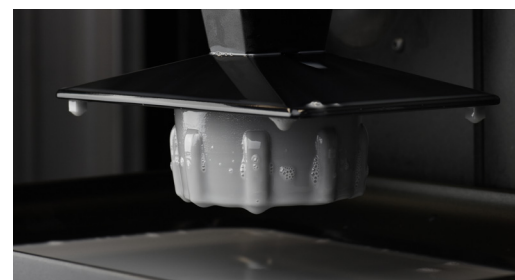
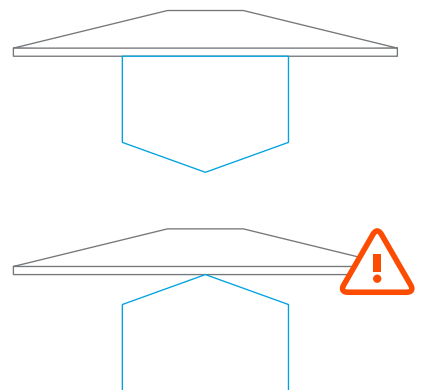
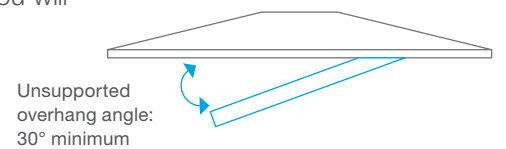
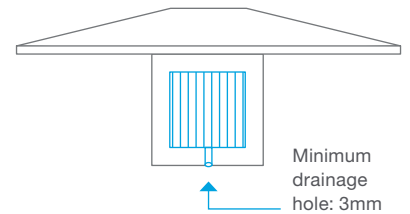
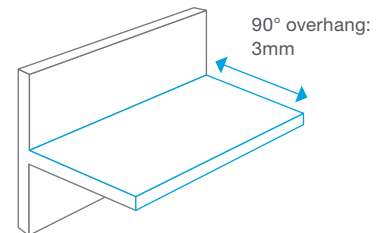
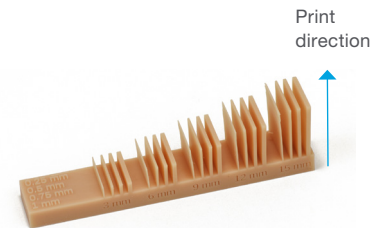



Summary

- The Stratasys Origin One is capable of producing end-use parts with features and surface quality comparable to CNC machining and injection molding, while taking advantage of additive manufacturing's design capabilities.
- Designing for additive manufacturing helps companies accelerate the introduction of additive into their production process. The key to finding success is to step back and re-examine parts from a system level and optimize parts for light weighting, performance, and throughput, and therefore develop a more cost-effective and compelling business case.

Stratasys Headquarters

7665 Commerce Way,
Eden Prairie, MN 55344
+1 800 801 6491 (US Toll Free)
+1 952 937-3000 (Intl)
+1 952 937-0070 (Fax)

stratasys.com
ISO 9001:2015 Certified

1 Holtzman St., Science Park,
PO Box 2496
Rehovot 76124, Israel
+972 74 745 4000
+972 74 745 5000 (Fax)

